

# PRODUCT CATALOG 2023

## KEOFITT CLASSIC 4KAI



**KEOFITT**  
WORLD LEADERS IN STERILE SAMPLING™

# KEOFITT CLASSIC 4KAI SAMPLING VALVE

The KEOFITT CLASSIC 4KAI Sampling Valve is the smallest KEOFITT CLASSIC valve available. It is designed for the sampling of low viscosity products in the range of 0-100 cP with particles less than 1.5 mm in diameter. Sampling of more viscous liquids is possible, only will it take longer (depending on process pressure).

This valve is used in a range of industries such as brewery, dairy, pharmaceutical and bio-tech for products such as:



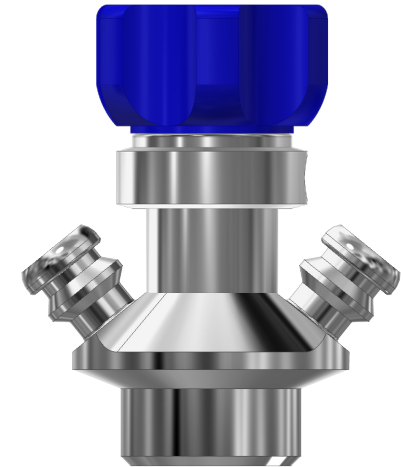

- Water
- Milk
- Medical solutions
- Filtered Beer
- Perfume
- Olive Oil

Besides the selection of the Valve Body and the Valve Head there are three different membrane materials to choose from: Silicone, EPDM and PTFE.









Accessories include quick couplings for the connection of tubing, piping and more.



















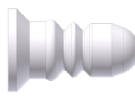

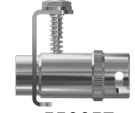



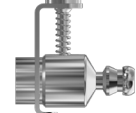
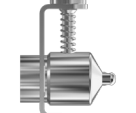
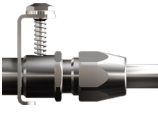









# KEOFITT CLASSIC 4KAI VALVE - BODIES

|                    | WELDING BODIES   |  |  | CONNECTION BODIES   |  |
|--------------------|--|--|--|---|--|
|                    | TANK WELDING   | PIPE WELDING   | PIPE WELDING NW25  | MINI CLAMP  | CLAMP 1" & 1½"   |
| <b>4KAI BODIES</b> | HOSE PIECE   |  |  |   |  |
|                    |  |  |  |  |  |
|                    | 440001   | 440011   | 440014   | 440021  | 440022   |

# KEOFITT CLASSIC 4KAI VALVE - HEADS

|                   | TYPE H<br>TURN KNOB<br>0-6 BAR (G)  | TYPE Q<br>LEVER HANDLE<br>0- 6 BAR (G)  | TYPE N<br>PNEUMATIC<br>0-6 BAR (G)  |
|-------------------|---|---|---|
| <b>4KAI HEADS</b> |    |    |    |
| SILICONE          | 440041  | 440043  | 440044  |
|                   |    |    |    |
| EPDM              | 440041E   | 440043E   | 440044E   |
|                   |  |  |  |
| PTFE              | 445541  | 445543  | 445544  |

# KEOFITT CLASSIC 4KAI - PARTS & ACCESSORIES

|                              |  |  |   |  |   |   |  |  |   |  |  |
|------------------------------|--|--|---|--|---|---|--|--|---|--|--|
| INGOLD - PARTS & ACCESSORIES | O-RINGS  | <br>800830<br>10.3X2.4 SILIC          | <br>800830E<br>EPDM 10.3X2.4                 | <br>550184<br>FESTO                 | <br>600825<br>SILICONE 7.1X1.6 |   |  |  |   |  |  |
|                              | MEMBRANES  | <br>400051<br>SILICONE                | <br>400052<br>EPDM                           | <br>400055<br>PTFE                  |   |   |  |  |   |  |  |
|                              | FOR HOSE PIECE   | <br>550003<br>PTFE QC 1.0M            | <br>550002<br>PTFE QC 0.5M                   | <br>550057<br>KÄRCHER<br>ADAPTOR    | <br>600062<br>RUBBER CAP       | <br>800053<br>QC/QC W9         | <br>800082<br>QC HOSE BARB 3/8    | <br>800083<br>QC TC               | <br>800086<br>QC W9 WITH M4 HP                 | <br>800061<br>QC PLUG                     | <br>800070<br>QC STEEL PIPE |
|                              |  | <br>900045<br>QC SYRINGE<br>INJECTION | <br>900031<br>HP MALE THREAD<br>M12          | <br>800058<br>COIL                  | <br>800059<br>XL COIL          | <br>800091<br>QC PTFE          |  |  |   |  |  |
|                              | VALVE HEADS  | <br>900018<br>TOMMY BAR             | <br>600370<br>LEVER HANDLE<br>SELF-CLOSING | <br>600170<br>LEVER HANDLE<br>Q/N | <br>400255<br>TOOL PTFE      |   |  |  |   |  |  |
| MISC.                        | <br>440064<br>DOUBLE ST. ST.<br>CHAIN | <br>900086<br>CLAMP RING 1"         | <br>900075<br>CLAMP RING 1/2"              | <br>900047<br>TUBE PTFE 10/8      | <br>900087<br>GASKET 1/2"  | <br>900091<br>GASKET EPDM 1" | <br>550002.2<br>PTFE QC/TC 0.5M | <br>550003.2<br>PTFE QC/TC 1.0M | <br>440149<br>BUSHING FOR<br>4KAI/BASIX HEAD | <br>800052<br>HOSE PIECE/<br>HOSE PIECE |  |

# PRODUCT CATALOG 2021

## KEOFITT CLASSIC W9



**KEOFITT**  
WORLD LEADERS IN STERILE SAMPLING™

## KEOFITT CLASSIC

Coaxial steam sterilizable design with separate inlet for SIP and CIP: The reference for hygienic and microbiological sampling for four decades, this is the original, in-situ sterilizable sampling valve that continues to revolutionize the field of sterile sampling.

Refined over the years - inside electro-polish being the latest addition - it remains the most popular and best selling valve in the market by far. It is based on Keofitt's unique, patented membrane and is used in more than 300,000 sampling points worldwide.

Available in several models/sizes:

- W9 (ID 9 MM)
- "INGOLD" (ID 9 MM)
- 4KAI (ID 5 MM)
- W15 (ID 15MM)
- W25 (ID 25MM)



## HOW IT WORKS

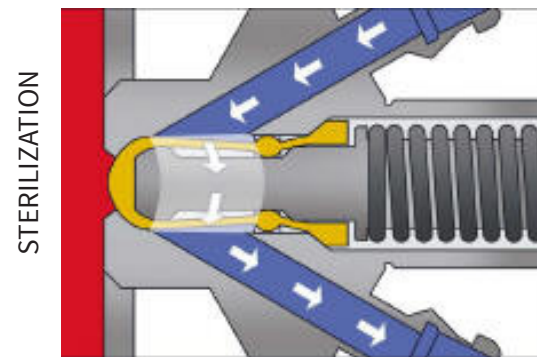
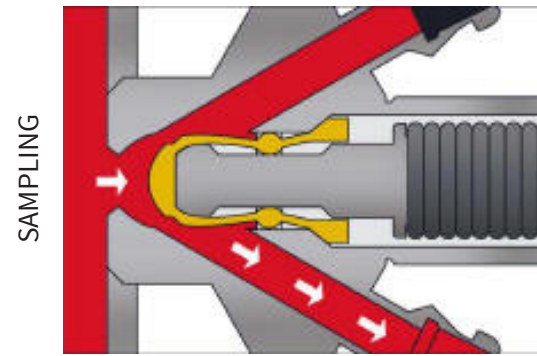

## KEOFITT CLASSIC W9 SAMPLING VALVE

The KEOFITT CLASSIC W9 Sampling Valve is considered the father of all steam-sterilizable sampling valves. Refined through 40 years of experience it remains KEOFITT's most popular sampling valve. Designed for the sampling of medium viscosity products in the range of 0-1000 cP with particles less than 3 mm in diameter, it covers most needs for liquid sampling. Sampling of more viscous liquids is possible, only will it take longer (depending on process pressure).

This valve is used in a range of industries such as brewery, dairy, pharmaceutical and bio-tech for products such as:









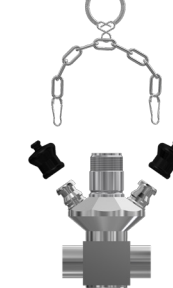

- Medical solutions
- Filtered Beer
- Creams and lotions
- Unprocessed milk

Besides the selection of the Valve Body and the Valve Head there are three different membrane materials to choose from: Silicone, EPDM and PTFE.

Accessories include quick couplings for the connection of tubing, piping and more.









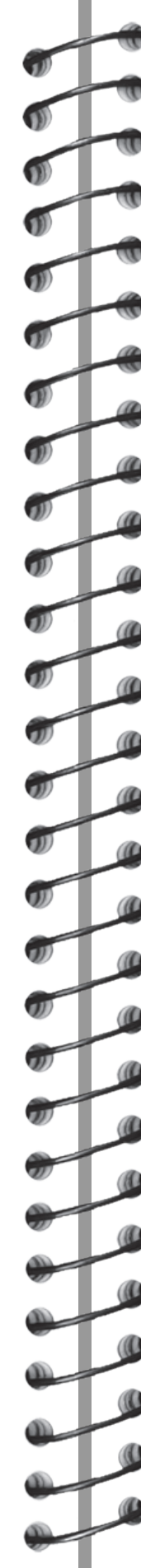



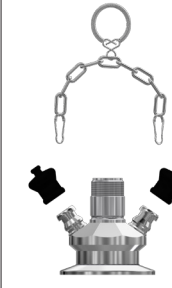
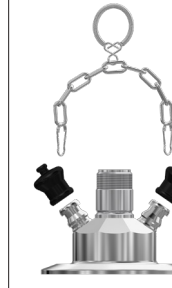

# KEOFITT CLASSIC W9 SAMPLING VALVE - BODIES

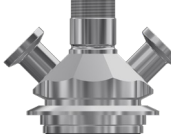
|                   | WELDING BODIES  |   |   |  |  |
|-------------------|---|---|---|--|--|
|                   | TANK WELDING  | PIPE WELDING 1"   | PIPE WELDING NW25   | IN-LINE VERTICAL   | IN-LINE HORIZONTAL   |
| HOSE PIECE        | <br>850001   | <br>850011   | <br>850014   | <br>850027* | <br>850028* |
| 1/2" TRI-CLAMP    | <br>850006   | <br>850010   | <i>On request</i>   | <i>On request</i>  | <i>On request</i>  |
| THREAD M16X1,5    | <br>850015 | <br>850016 | <br>850018 | <i>On request</i>  | <i>On request</i>  |
| 1/2" WELDING ENDS | <br>850007 | <br>850019 | <i>On request</i>   | <i>On request</i>  | <i>On request</i>  |



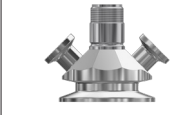

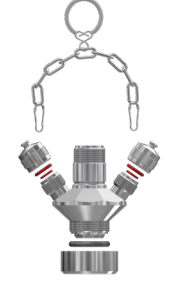







\* ON REQUEST ONLY!



| CONNECTION BODIES   |   |   |   |   |   |   |
|---|---|---|---|---|---|---|
| VARIVENT Ø50  | VARIVENT Ø68  | MINI CLAMP  | CLAMP 1" & 1½"  | CLAMP 2"  | CLAMP 3"  | THREAD M28X1,5  |
| <br>850008 | <br>850009 | <br>850036 | <br>850021   | <br>850003   | <br>850004 | <br>M28X1,5<br>850031<br>DIN 11851 DN 10<br>850040 |
| <br>850020 | <br>850013 | <br>850039 | <br>850022<br><br>850025 | <br>850005<br><br>850026 | <i>On request</i>   |   |
| <i>On request</i>   | <i>On request</i>   | <i>On request</i>   | <br>850024   | <i>On request</i>   | <i>On request</i>   | <br>850037<br>M28X1,5                            |
| <i>On request</i>   | <i>On request</i>   | <i>On request</i>   | <i>On request</i>   | <i>On request</i>   | <i>On request</i>   |   |













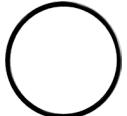
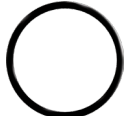





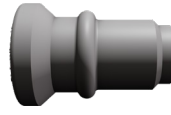

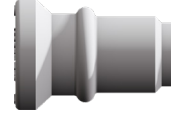
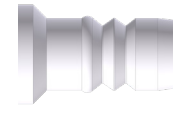

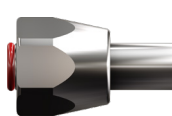





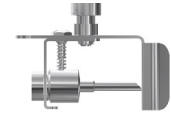

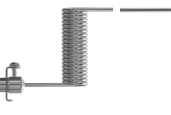
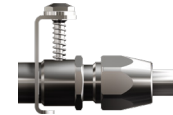













# KEOFITT CLASSIC W9 SAMPLING VALVE - HEADS

|          |          | TYPE H<br>TURN KNOB<br>0-10 BAR (FFKM 0-6 BAR)   | TYPE H<br>TURN KNOB W/. MICROPORT<br>0-10 BAR  | TYPE K<br>KEY RING<br>0-10 BAR (FFKM 0-6 BAR)  | TYPE K<br>KEY RING W/OPT. MICROPORT<br>0-10 BAR  |
|----------|----------|--|--|--|--|
|          |          | W9 HEADS   |  |  |  |
| W9 HEADS | SILICONE | <br>600041    | <br>600048  | <br>600042    | <br>600049  |
|          | EPDM     | <br>600041E   | <br>600048E | <br>600042E   | <br>600049E |
|          | FFKM     | <br>600041F | <i>Not available</i>   | <br>600042F | <i>Not available</i>   |
|          | PTFE     | <br>855541  | <i>Not available</i>   | <br>855542  | <i>Not available</i>   |









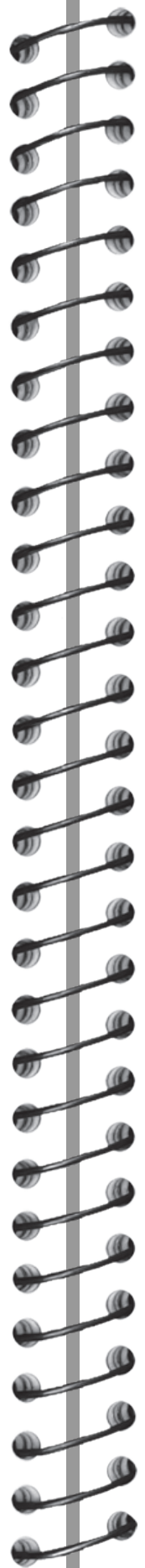



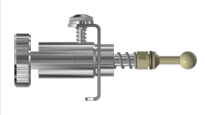





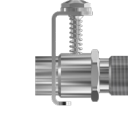

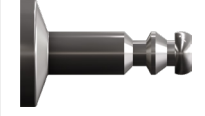

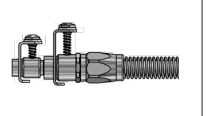



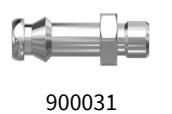

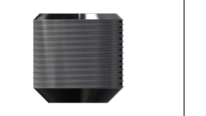

| TYPE Q<br>LEVER HANDLE<br>0-10 BAR (FFKM 0-6 BAR)  | TYPE N<br>PNEUMATIC<br>0-10 BAR (FFKM 0-6 BAR)   | TYPE N<br>PNEUMATIC, ADJUSTABLE<br>0-10 BAR (FFKM 0-6 BAR)                                       | TYPE B<br>NO SPRING<br>0-12 BAR(G)   |
|--|--|--|--|
| <br>600043    | <br>600044    | <br>600045    | <br>600047    |
| <br>600043E   | <br>600044E   | <br>600045E   | <br>600047E   |
| <br>600043F | <br>600044F | <br>600045F | <br>600047F |
| <br>855543  | <br>855544  | <br>855545  | <br>855547  |

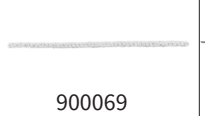
# KEOFITT CLASSIC W9 - PARTS & ACCESSORIES

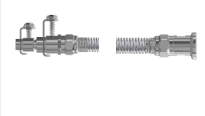
## W9™ PARTS & ACCESSORIES

|                        |   |   |   |  |   |  |
|------------------------|---|---|---|--|---|--|
| O-RINGS                | <br>400208<br>EPDM 60X3              | <br>400308<br>EPDM 42X3              | <br>550184<br>FESTO                            | <br>600825<br>SILICONE 7.1X1.6   | <br>600825E<br>EPDM 7.1X1.6                  | <br>800830<br>10.3X2.4 SILIC            |
| MEMBRANES              | <br>600051<br>SILICONE               | <br>600052<br>EPDM                   | <br>600251<br>SILICONE MP                      | <br>600252<br>EPDM MP            | <br>600053<br>FFKM                           | <br>850055<br>PTFE                      |
| FOR THREAD<br>M16X1,5  | <br>700061<br>STEEL CAP              | <br>700070<br>TUBE FITTING WL        | <br>700071<br>TUBE FITTING PTFE                | <br>700084<br>BARB 4MM           | <br>700085<br>BARB 6MM                       | <br>700062<br>HP W9 16X1.5              |
| FOR HOSE<br>PIECE      | <br>550057<br>KÄRCHER ADAPTOR        | <br>600062<br>RUBBER CAP             | <br>800013<br>QC SPIKE                         | <br>800058<br>COIL               | <br>800059<br>XL COIL                        | <br>800070<br>QC STEEL PIPE             |
| FOR MINI TRI-<br>CLAMP | <br>300021<br>CLAMP PTFE 10/8      | <br>550004<br>PTFE TC 0.5M         | <br>550005<br>PTFE TC 1.0M                   | <br>800014<br>ADAPTER TC/1"    | <br>900013<br>MINI CLAMP SPIKE             | <br>900096<br>ADAPTOR<br>W9/W15 HP/TC |
| FOR VALVE<br>HEADS     | <br>600076<br>KEY RING             | <br>600149<br>BUSHING              | <br>600170<br>LEVER HANDLE Q/N               | <br>600255<br>TOOL PTFE        | <br>600370<br>LEVER HANDLE<br>SELF-CLOSING | <br>900018<br>TOMMY BAR               |
| MISC.                  | <br>600063<br>SINGLE ST. ST. CHAIN | <br>600064<br>DOUBLE ST. ST. CHAIN | <br>600066<br>SINGLE ST. ST. CHAIN<br>W/HOOK | <br>400166<br>PROXIMITY SENSOR | <br>600266<br>PROXIMITY SENSOR             | <br>600267<br>PROXIMITMOUNTING<br>KIT |
|                        | <br>900047<br>TUBE PTFE 10/8       | <br>900186<br>CLAMP RING 2"        | <br>900075<br>CLAMP RING 1/2"                | <br>900086<br>CLAMP RING 1"    | <br>900021<br>BLIND CAP                    | <br>900076<br>BLIND CAP 1"            |



|  |  |  |   |  |  |  |
|--|--|--|---|--|--|--|
| <br>800830E<br>EPDM 10.3X2.4      | <br>800859<br>SILICONE 7.5X2.5            | <br>900829<br>EPDM 21X4                   |   |  |  |  |
| <br>800077<br>EMERGENCY TOOL      |  |  |   |  |  |  |
|  |  |  |   |  |  |  |
| <br>800061<br>QC PLUG             | <br>800082<br>QC HOSE BARB 3/8            | <br>800083<br>QC TC                       | <br>800086<br>QC W9 WITH M4 HP | <br>900045<br>QC SYRINGE<br>INJECTION           | <br>800171<br>QC PTFE M16X1.5           | <br>800085<br>QC W9 LUER LOCK<br>ADAPTER        |
| <br>900097<br>ADAPTER M4 HP/TC  |  | <br>550002<br>PTFE QC 0.5M              | <br>550003<br>PTFE QC 1.0M   | <br>800091<br>QC W/HOSE BARB<br>FOR PTFE 10/8 | <br>800088<br>QC HOSE BARB<br>Ø4      | <br>800095<br>QC W9 MALE LUER<br>LOCK ADAPTER |
|  |  |  |   |  |  | <br>900031<br>HP MALE THREAD<br>M12           |
| <br>700108<br>HOSE PIECE        | <br>800052<br>HOSE PIECE/<br>HOSE PIECE | <br>800075<br>WELDING PIECE<br>FOR PTFE | <br>850840<br>PINOL SCREW    | <br>900008<br>SOCKET ALU-TANKS                | <br>900069<br>WICK FOR W9 VALVE<br>MP | <br>900022<br>NEEDLE                          |
| <br>550002.2<br>PTFE QC/TC 0.5M | <br>550003.2<br>PTFE QC/TC 1.0M         | <br>900092<br>GASKET EPDM 2"            | <br>900093<br>GASKET EPDM 3" | <br>900074<br>GASKET EPDM 3/4"                | <br>900087<br>GASKET 1/2"             | <br>900091<br>GASKET EPDM 1"                  |

# PRODUCT CATALOG 2021

## KEOFITT CLASSIC W15



**KEOFITT**  
WORLD LEADERS IN STERILE SAMPLING™

## HOW IT WORKS

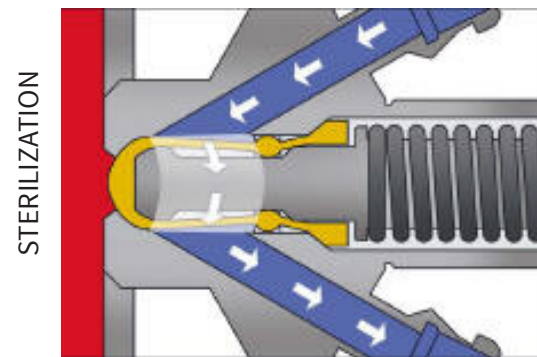
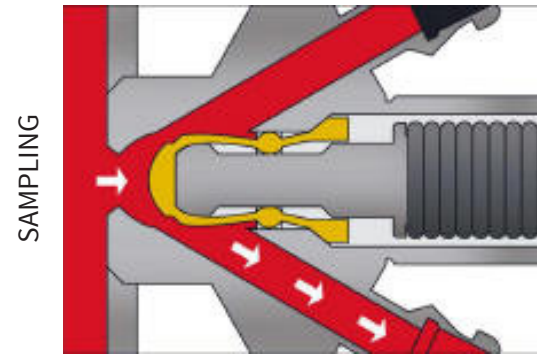

## KEOFITT CLASSIC W15 SAMPLING VALVE

The KEOFITT CLASSIC W15 Sampling Valve is designed for high viscosity products in the range of 0-50,000 cP with particles up to 8 mm in diameter. Sampling of more viscous liquids is possible, only will it take longer (depending on process pressure).



This valve is used in a range of industries such as brewery, dairy, pharmaceutical and bio-tech for products such as:

- Yoghurt
- Honey
- Syrup
- Ketchup
- Marmalade
- Creams and lotions
- Fruit pulp products

Available with PTFE membrane.



# KEOFITT CLASSIC W15 SAMPLING VALVE - BODIES

|                   |                   | WELDING BODIES  |   |
|-------------------|-------------------|---|---|
|                   |                   | TANK WELDING  | PIPE WELDING  |
| <b>W15 BODIES</b> | 3/4" TRI-CLAMP    |  <p>860001</p>   |  <p>860011</p> |
|                   | 3/4" WELDING ENDS |  <p>860007</p> | <i>On request</i>   |

| CONNECTION BODIES   |   |   |   |
|---|---|---|---|
| VARIVENT Ø68  | CLAMP 1"  | CLAMP 2"  | CLAMP 3"  |
|  <p>860009</p> |  <p>860004</p> |  <p>860002</p> |  <p>860003</p> |
| <i>On request</i>   | <i>On request</i>   | <i>On request</i>   |   |

# KEOFITT CLASSIC W15 SAMPLING VALVE - HEADS





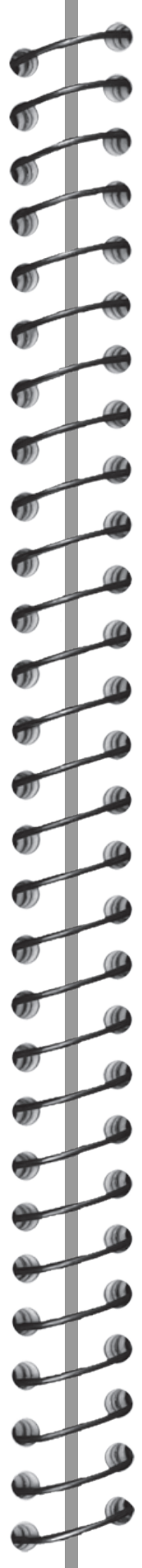





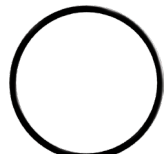

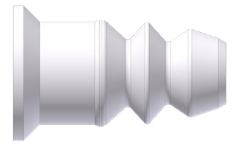
|           |  |  |
|-----------|--|--|
| W15 HEADS | <p>TYPE H<br/>TURN KNOB<br/>0-10 BAR (G)</p>   | <p>TYPE B<br/>NO SPRING<br/>0-12 BAR (G)</p>   |
|           |  <p>865541</p> |  <p>865547</p> |

PTFE





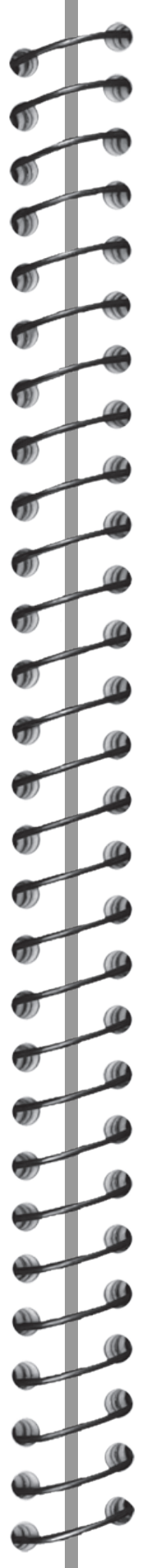

|  |
|--|
| <p>TYPE N<br/>PNEUMATIC<br/>0-10 BAR (G)</p>   |
|  <p>865544</p> |

# KEOFITT CLASSIC W15 - PARTS & ACCESSORIES

|                          |                    |   |   |   |
|--------------------------|--------------------|---|---|---|
| W15™ PARTS & ACCESSORIES | O-RINGS            | <br>400208<br>EPDM 60X3          | <br>550184<br>FESTO                          |   |
|                          | MEMBRANES          | <br>860055<br>PTFE               |   |   |
|                          | FOR MINI TRI-CLAMP | <br>300021<br>CLAMP PTFE 10/8    | <br>550004<br>PTFE TC 0.5M                  | <br>550005<br>PTFE TC 1.0M     |
|                          | FOR VALVE HEADS    | <br>600170<br>LEVER HANDLE Q/N | <br>600370<br>LEVER HANDLE<br>SELF-CLOSING | <br>860255<br>TOOL PTFE      |
|                          | MISC.              | <br>900075<br>CLAMP RING 1/2"  | <br>900074<br>GASKET EPDM 3/4"             | <br>900092<br>GASKET EPDM 2" |

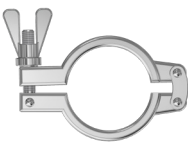

|   |  |   |
|---|--|---|
|   |  |   |
|   |  |   |
| <br>800014<br>ADAPTER TC/1"   | <br>900013<br>MINI CLAMP SPIKE | <br>900096<br>ADAPTER HP/TC |
|   |  |   |
| <br>900093<br>GASKET EPDM 3" | <br>900186<br>2" CLAMP RING   |   |

# PRODUCT CATALOG 2021

## KEOFITT CLASSIC W25



**KEOFITT®**  
WORLD LEADERS IN STERILE SAMPLING™



## HOW IT WORKS

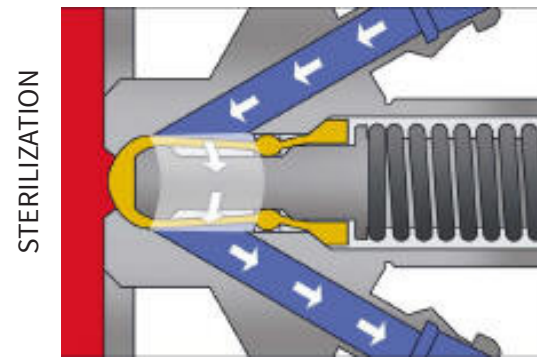
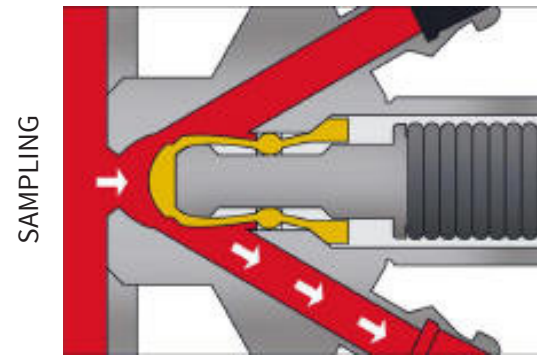

## KEOFITT CLASSIC W25 SAMPLING VALVE

The KEOFITT CLASSIC W25 Sampling Valve is the largest KEOFITT sampling valve. Designed for sampling of very high viscosity products in the range of 0-250,000 cP and particles less than 17 mm in diameter. Sampling of more viscous liquids is possible, only will it take longer (depending on process pressure).

This valve is used in a range of industries such as food, dairy, pharmaceutical and bio-tech for products such as:

- Peanut Butter
- Fruit Pulp
- Syrup
- Cellulose
- Fruit Mixed Products
- Cosmetics

Available with PTFE membrane.

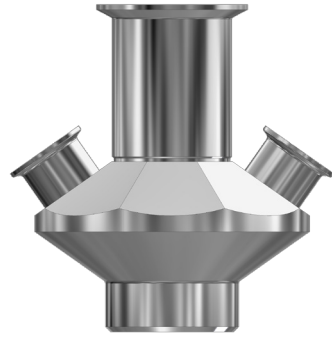

# KEOFITT CLASSIC W25 SAMPLING VALVE - BODIES

|            |               | WELDING BODIES  |                          |
|------------|---------------|---|--------------------------|
|            |               | TANK WELDING  | PIPE WELDING             |
| W25 BODIES | 1" CLAMP      |  <p>870001</p> | <p><i>On request</i></p> |
|            | VELDING LINER | <p><i>On request</i></p>  | <p><i>On request</i></p> |

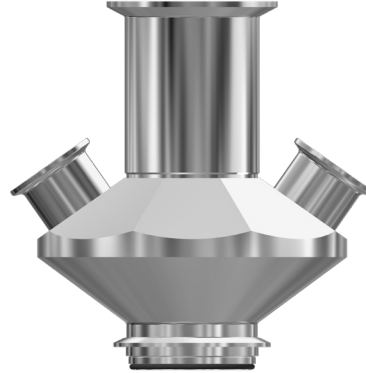
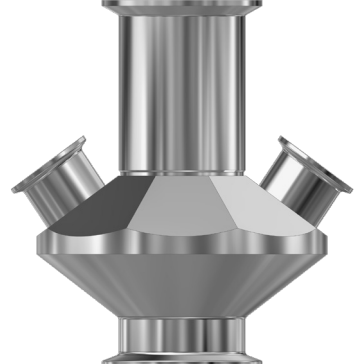
|  |  | CONNECTION BODIES   |   |
|--|--|---|---|
|  |  | VARIVENT Ø68  | CLAMP 3"  |
|  |  |  <p>870009</p> |  <p>870003</p> |
|  |  | <p><i>On request</i></p>  | <p><i>On request</i></p>  |

# KEOFITT CLASSIC W25 SAMPLING VALVE - HEADS

W25 HEADS

PTFE

TYPE N  
LEVER HANDLE  
PNEUMATIC









875544

TYPE B  
NO SPRING  
0-12 BAR

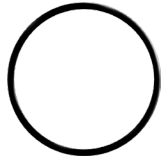

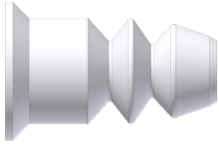
875547

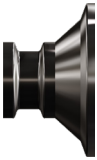
# KEOFITT CLASSIC W25 - PARTS & ACCESSORIES

|                          |                 |  |  |   |
|--------------------------|-----------------|--|--|---|
| W25™ PARTS & ACCESSORIES | O-RINGS         | <br>400208<br>EPDM 60X3       | <br>900091<br>GASKET EPDM 1"  |   |
|                          | MEMBRANES       | <br>870055<br>PTFE            |  |   |
|                          | FOR VALVE HEADS | <br>870255<br>TOOL PTFE     |  |   |
|                          | MISC.           | <br>900086<br>CLAMP RING 1" | <br>800014<br>ADAPTER TC/1" | <br>900093<br>GASKET EPDM 3" |

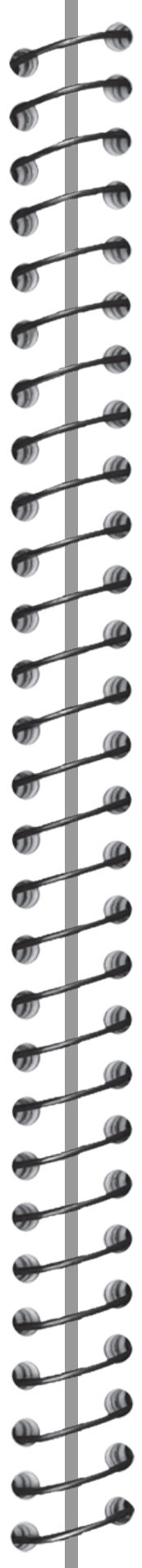

|   |  |  |
|---|--|--|
|   |  |  |
|   |  |  |
|   |  |  |
| <br>900187<br>CLAMP RING FOR W25 VALVE |  |  |